



FRAMED DOOR HANDLES

Our elegant range of products for your door

Issue 2024



DIN EN 179



DIN 18273



Klasse 4

DIN EN

1906

blaugelb®

Die Kundenmarke.





FRAMED DOOR HANDLES

Note on the framed door handle series in this brochure:

The **framed door handle series** always comprises a base handle on the inside and an exterior handle that can be selected accordingly. This can either be a handle or a knob. We also offer each handle shape as an individual handle.

The attractive framed door handles and sets are available in seven different shapes and elegantly combine form and function. All door handles can be used in the property sector and are available in the Class 4 and fire safety use classes and as anti-panic sets, depending on the handle shape.

Each of the shapes is available as an individual handle, individual knob, lever handle set or knob/handle set, each with three different knob forms.

- 
Individual handle, intended for upgrading
- 
Individual knob, intended for upgrading
- 
Classic lever handle set, identical handles on both sides
- 
Variable knob/handle set, the respective door handle from the series on the inside and a selection of three different knobs on the outside

The topics covered in this brochure:

Standards in detail	Page 4	blaugelb	90° shape offset framed door handle series	Page 11
blaugelb Accessories	Page 5	 		
blaugelb U-shape framed door handle series	Page 8	  	blaugelb 90° U-shape framed door handle series	Page 12
blaugelb U-shape offset framed door handle series	Page 9	  	blaugelb 90° U-shape offset framed door handle series	Page 13
blaugelb 90° shape framed door handle series	Page 10		blaugelb 45° U-shape framed door handle series	Page 14
		  		

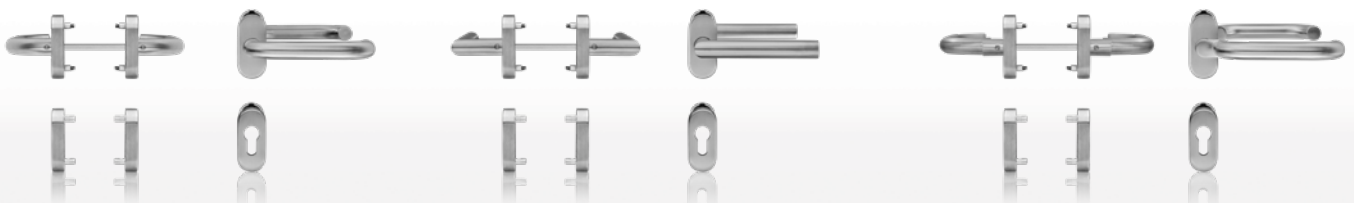

blaugelb Framed Door Handle Class 4

DIN EN 1906

In 2001, the DIN standard **EN 1906** was drafted and adopted on the European level. It defines the requirements and test methods for door handles and door knobs. The properties of a handle or knob are shown by an eight-character classification code.

Classification codes of our framed door handles:

1st digit	2nd digit	3rd digit	4th digit	5th digit	6th digit	7th digit	8th digit
Category of use	Durability	Door mass	Fire resistance	Safety	Corrosion resistance	Security	Type of operation
4	7	-	B1	1	5	0	B

- 1 | **4** = Class 4
- 2 | **7** = 200,000 test cycles
- 3 | **-** = Not assigned
- 4 | **B1** = Suitable for fire and smoke protection doors (200,000 test cycles)
- 5 | **1** = Safety applications
- 6 | **5** = Extremely high corrosion resistance (480 h salt spray test)
- 7 | **0** = Not burglary-resistant
- 8 | **B** = With spring loading

blaugelb Framed Door Handle fire safety

DIN EN 18273

Framed door handles in accordance with the standard **DIN 18273** are attached to doors that are intended to prevent the spread of fire. Fire doors are self-closing and must be functional for a duration of 200,000 opening and closing operations.

DIN 18273 applies for all framed door lever handle sets that are installed on fire and smoke protection doors. In addition to the door handles, a fire door requires additional tested components such as the lock case, the door hinges and the door closers in order to be able to be declared as such.

Fire and smoke protection doors are usually in use for long periods, meaning that repairs and replacements are required over time. The basic use of and any modification to components of the door must be approved by the building inspectorate. In addition, no further modifications can be made after the approval of doors as this could potentially compromise compliance with the requirements of **DIN 18273**.

Fire door handle sets must also be equipped with a square pin that has a cross section of at least 9 x 9 mm and is made of steel. All sets and their components must be made out of materials that have a melting point of 1,000 °C or higher so that the door handle does not become unusable in the event of a fire and the fire door can still be used after a fire.

blaugelb Framed Door Handle anti-panic

DIN EN 179

According to **DIN EN 179:2008**, only completely approved lock systems are approved as a unit (lock, fitting, strike plate). Please note this before installation and especially in the event of separate delivery of the components. In the certificates of conformity no. 0432-EN 179-ift 230 8000244 (MPA NRW) and no. 1309-EN 179 0284 and 0287 (PIV Velbert), the certified closure manufacturers are specified which can be used with our tested handle models. Please request the certificate of constancy of performance **EN 179:2008** from the closure manufacturer.

The Anti-Panic Pin for the handle/handle version is to be selected in accordance with the schematic drawing so that it suits your door thickness and the door/lock combination.

Our blaugelb Anti-Panic Square Pins generally contain **two dimensions** in the name. The first of these is the interior dimension (**SI**) and the second is the exterior dimension (**SA**).

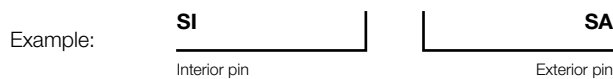

blaugelb Anti-Panic Square Pin 9 mm, 52/53.5 mm galv.

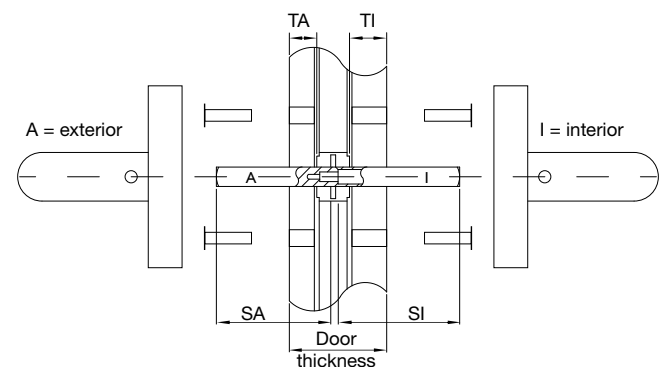

Grub screw installation:

The Anti-Panic Square Pin is aligned during installation so that the grub screws included in the scope of delivery can be easily screwed in on the intended side. This is only possible on one of the four sides.

When looking at the cross section (see figure), this is the narrowest of the four sides, which can be easily identified thanks to the asymmetrical construction.

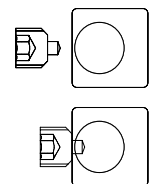

Accessories:

blaugelb Anti-Panic Square Pins

Product name	PU	Item no.
blaugelb Anti-Panic Square Pin 9 mm 52/53.5 mm galv. Length 106 mm	1 piece	9163909
blaugelb Anti-Panic Square Pin 9 mm 52/60.5 mm galv. Length 112 mm	1 piece	9163910
blaugelb Anti-Panic Square Pin 9 mm 52/67.5 mm galv. Length 119 mm	1 piece	9163911
blaugelb Anti-Panic Square Pin 9 mm 52/81.5 mm galv. Length 134 mm	1 piece	9163912
blaugelb Anti-Panic Square Pin 9 mm 59/53.5 mm galv. Length 112 mm	1 piece	9163913
blaugelb Anti-Panic Square Pin 9 mm 59/60.5 mm galv. Length 119 mm	1 piece	9163914
blaugelb Anti-Panic Square Pin 9 mm 59/67.5 mm galv. Length 126 mm	1 piece	9163915
blaugelb Anti-Panic Square Pin 9 mm 59/81.5 mm galv. Length 141 mm	1 piece	9163916

Product name	PU	Item no.
blaugelb Anti-Panic Square Pin 9 mm 66/53.5 mm galv. Length 119 mm	1 piece	9163917
blaugelb Anti-Panic Square Pin 9 mm 66/60.5 mm galv. Length 126 mm	1 piece	9163918
blaugelb Anti-Panic Square Pin 9 mm 66/67.5 mm galv. Length 134 mm	1 piece	9163919
blaugelb Anti-Panic Square Pin 9 mm 66/81.5 mm galv. Length 148 mm	1 piece	9163920
blaugelb Anti-Panic Square Pin 9 mm 120/53.5 mm galv. Length 173 mm	1 piece	9163921
blaugelb Anti-Panic Square Pin 9 mm 120/60.5 mm galv. Length 180 mm	1 piece	9163922
blaugelb Anti-Panic Square Pin 9 mm 120/67.5 mm galv. Length 188 mm	1 piece	9163923
blaugelb Anti-Panic Square Pin 9 mm 120/81.5 mm galv. Length 202 mm	1 piece	9163924

Additional information on the item is available on our website www.blaugelb.de or directly via the QR code



Accessories:

blaugelb Knob/Lever Spindles for blaugelb Framed Door Knob/Handle Set

The **blaugelb Knob/Lever Spindles** suitable for our blaugelb Framed Door Handles in combination with a blaugelb Knob or blaugelb **Framed Door Knob/Handle Sets**. The spindles are an add-on to the product range in order to cover **different door thicknesses (TS)**.

Class 4

Product name	PU	Item no.
blaugelb Knob/Lever Spindle with Thread 8 x 80 mm TS 32 – 58 mm, offset 48 – 58 mm	1 piece	9257231
blaugelb Knob/Lever Spindle with Thread 8 x 100 mm TS 52 – 78 mm, offset 68 – 78 mm	1 piece	9257232
blaugelb Knob/Lever Spindle with Thread 8 x 110 mm TS 62 – 88 mm, offset 78 – 88 mm	1 piece	9257233
blaugelb Knob/Lever Spindle with Thread 8 x 120 mm TS 72 – 98 mm, offset 88 – 98 mm	1 piece	9257254
blaugelb Knob/Lever Spindle with Thread 8 x 140 mm TS 92 – 118 mm, offset 108 – 118 mm	1 piece	9257255

Fire safety

Product name	PU	Item no.
blaugelb Knob/Lever Spindle with Thread FS 9 x 90 mm TS 42 – 68 mm, offset 58 – 68 mm	1 piece	9257257
blaugelb Knob/Lever Spindle with Thread FS 9 x 100 mm TS 52 – 78 mm, offset 68 – 78 mm	1 piece	9257258
blaugelb Knob/Lever Spindle with Thread FS 9 x 110 mm TS 62 – 88 mm, offset 78 – 88 mm	1 piece	9257259
blaugelb Knob/Lever Spindle with Thread FS 9 x 120 mm TS 72 – 98 mm, offset 88 – 98 mm	1 piece	9257260
blaugelb Knob/Lever Spindle with Thread FS 9 x 130 mm TS 82 – 108 mm, offset 98 – 108 mm	1 piece	9257261

blaugelb Square Pins for blaugelb Framed Door Handles and Sets

The **blaugelb Square Pins** suitable for our **blaugelb Framed Door Handles and Sets**. The spindles are an add-on to the product range in order to cover **different door thicknesses (TS)**.

Class 4

Product name	PU	Item no.
blaugelb Handle Square Pin 8 x 120 mm TS 18 – 70 mm, offset 50 – 70 mm	1 piece	9272083
blaugelb Handle Square Pin 8 x 140 mm TS 38 – 90 mm, offset 70 – 90 mm	1 piece	9272084
blaugelb Handle Square Pin 8 x 150 mm TS 48 – 100 mm, offset 80 – 100 mm	1 piece	9272085
blaugelb Handle Square Pin 8 x 180 mm TS 78 – 130 mm, offset 110 – 130 mm	1 piece	9272086

Fire safety

Product name	PU	Item no.
blaugelb Square Pin FS 9 x 140 mm TS 38 – 90 mm, offset 70 – 90 mm	1 piece	9271881

blaugelb Clip Rosette PZ oval 14 mm

Made of high-grade stainless steel and with a fine matt surface finish, the blaugelb Clip Rosette PZ oval is a persuasively elegant rosette solution for doors.

Product name	PU	Item no.
blaugelb Clip Rosette PZ oval 14 mm Fine matt stainless steel	1 piece	9163925

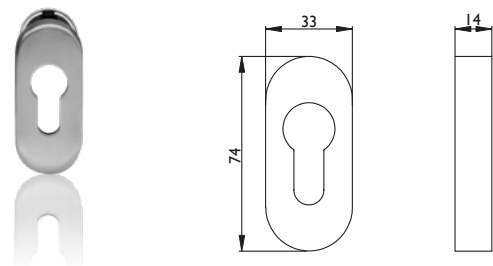

blaugelb PZ Ring

The blaugelb PZ Ring is used for the concealed installation of the profile cylinder in the door element and also on wing-covering door infill panels.

Product name	PU	Item no.
blaugelb PZ Ring 14 mm Fine matt stainless steel	1 piece	9257230

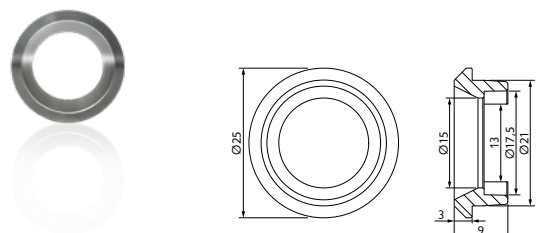

Accessories:

blaugelb Ball Knob straight on oval rosette

The attractive, elegant blaugelb Ball Knob straight made of fine matt stainless steel is suitable for aluminium and plastic doors and is prepared for an M12 knob/lever spindle.

The knob is mounted by means of concealed screws (supplied).

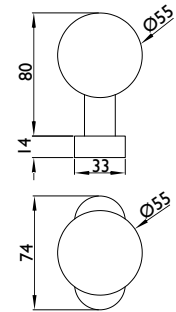

Product name	PU	Item no.
blaugelb Ball Knob straight on oval rosette Fine matt stainless steel	1 piece	9257227

blaugelb Ball Knob offset on oval rosette

The attractive, elegant blaugelb Ball Knob offset made of fine matt stainless steel is suitable for aluminium and plastic doors and is prepared for an M12 knob/lever spindle.

The knob is mounted by means of concealed screws (supplied).

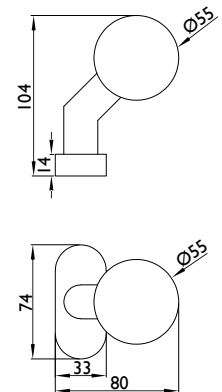

Product name	PU	Item no.
blaugelb Ball Knob offset on oval rosette Fine matt stainless steel	1 piece	9257228

blaugelb Flat Knob offset on oval rosette

The attractive, elegant blaugelb Flat Knob offset made of fine matt stainless steel is suitable for aluminium and plastic doors and is prepared for an M12 knob/lever spindle.

The knob is mounted by means of concealed screws (supplied).

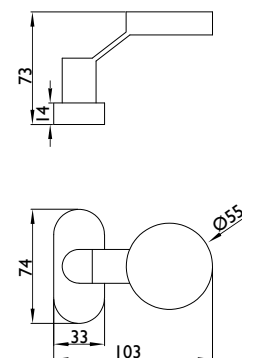

Product name	PU	Item no.
blaugelb Flat Knob offset on oval rosette Fine matt stainless steel	1 piece	9257229

U-SHAPE



Depending on the design, the **U-shape framed door handle series** is available for the following application areas:

- **Class 4**
- **Fire safety**
- **Anti-panic**

FEATURES

Material:

Fine matt stainless steel

DIN direction:

Can be used on both sides with double spring system

Keyhole:

Profile cylinder

Rosette dimensions:

33 x 74 mm (W x H)

Rosette height:

14 mm

Packing unit:

1 set incl. fastening & square pin

(Square pin for anti-panic handle/handle sets must be selected and ordered separately, see also note on page 5)

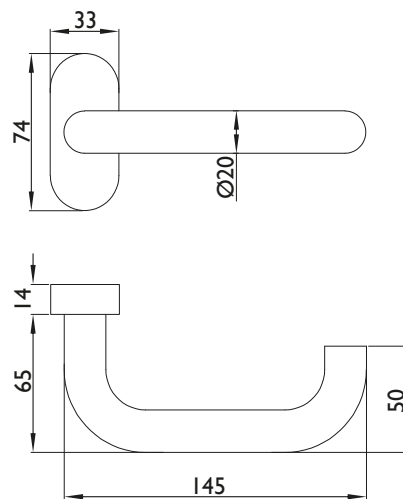

Maintenance-free plain bearing

Retaining spring for precise positioning

Can be used on DIN left/right



























Concealed screws

Additional information on the item is available on our website www.blaugelb.de or directly via the QR code



Version overview:

The framed door handle series in the handle shape U-shape is available in the **following versions**.

	U-shape Class 4 Item no.: 9131089		
	U-shape fire safety & anti-panic Item no.: 9131114		  
	U-shape Class 4 Item no.: 9131090	Prepared for: TS 40 – 90 mm	
	U-shape fire safety Item no.: 9131115	Prepared for: TS 40 – 90 mm	 
	U-shape anti-panic Item no.: 9163904 (suitable anti-panic square pin on page 5)		  
	U-shape/knob Class 4 Item no.: 9131091	Prepared for: TS 65 – 88 mm	
	U-shape/knob offset Class 4 Item no.: 9131092	Prepared for: TS 65 – 88 mm	
	U-shape/knob flat offset Class 4 Item no.: 9131093	Prepared for: TS 65 – 88 mm	
	U-shape/knob fire safety & anti-panic Item no.: 9131116	Prepared for: TS 65 – 88 mm	  
	U-shape/knob offset fire safety & anti-panic Item no.: 9131117	Prepared for: TS 65 – 88 mm	  
	U-shape/knob flat offset fire safety & anti-panic Item no.: 9131118	Prepared for: TS 65 – 88 mm	  
	Clip Rosette PZ oval 14 mm Item no.: 9163925 (see also page 6)		

Note: On **pages 5 to 7** you will find the **suitable accessories** for our blaugelb Framed Door Handle series.



The **check of the sets** was performed in pairs according to the **specification of DIN 1906, DIN 18273 or DIN EN 179.**

The **knob/handle sets fire safety & anti-panic** can be used as an anti-panic set with the **included pin** as, contrary to purely lever handle sets, knob/handle sets do not require a split pin.

U-SHAPE OFFSET



Depending on the design, the **U-shape offset framed door handle series** is available for the following application areas:

- **Class 4**
- **Fire safety**
- **Anti-panic**

FEATURES

Material:

Fine matt stainless steel

DIN direction:

Can be used on both sides with double spring system

Keyhole:

Profile cylinder

Rosette dimensions:

33 x 74 mm (W x H)

Rosette height:

14 mm

Packing unit:

1 set incl. fastening & square pin

(Square pin for anti-panic handle/handle sets must be selected and ordered separately, see also note on page 5)

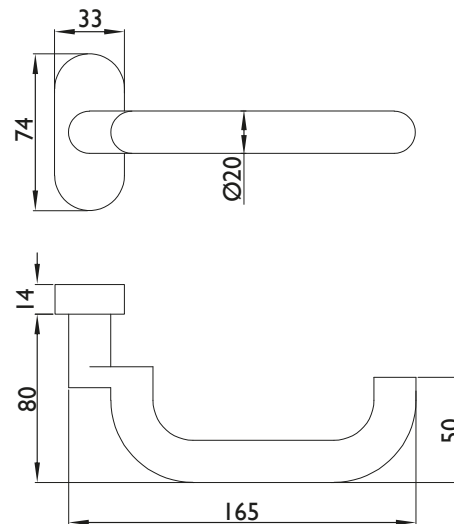

Maintenance-free plain bearing

Retaining spring for precise positioning

Can be used on DIN left/right



























Concealed screws

Additional information on the item is available on our website www.blaugelb.de or directly via the QR code



Version overview:

The framed door handle series in the handle shape U-shape offset is available in the **following versions**.

	U-shape offset Class 4 Item no.: 9131139		
	U-shape offset fire safety & anti-panic Item no.: 9131144		  
	U-shape offset Class 4 Item no.: 9131140	Prepared for: TS 74 – 90 mm	
	U-shape offset fire safety Item no.: 9131145	Prepared for: TS 74 – 90 mm	 
	U-shape offset anti-panic Item no.: 9163905 (suitable anti-panic square pin on page 5)		  
	U-shape offset/knob Class 4 Item no.: 9131141	Prepared for: TS 80 – 88 mm	
	U-shape offset/knob offset Class 4 Item no.: 9131142	Prepared for: TS 80 – 88 mm	
	U-shape offset/knob flat offset Class 4 Item no.: 9131143	Prepared for: TS 80 – 88 mm	
	U-shape offset/knob fire safety & anti-panic Item no.: 9131146	Prepared for: TS 80 – 88 mm	  
	U-shape offset/knob offset fire safety & anti-panic Item no.: 9131147	Prepared for: TS 80 – 88 mm	  
	U-shape offset/knob flat offset fire safety & anti-panic Item no.: 9131148	Prepared for: TS 80 – 88 mm	  
	Clip Rosette PZ oval 14 mm Item no.: 9163925 (see also page 6)		

Note: On **pages 5 to 7** you will find the **suitable accessories** for our blaugelb Framed Door Handle series.



The **check of the sets** was performed in pairs according to the **specification of DIN 1906, DIN 18273 or DIN EN 179.**

The **knob/handle sets fire safety & anti-panic** can be used as an anti-panic set with the **included pin** as, contrary to purely lever handle sets, knob/handle sets do not require a split pin.



Depending on the design, the **90° shape framed door handle series** is available for the following application areas:

- **Class 4**
- **Fire safety**

FEATURES

Material:

Fine matt stainless steel

DIN direction:

Can be used on both sides with double spring system

Keyhole:

Profile cylinder

Rosette dimensions:

33 x 74 mm (W x H)

Rosette height:

14 mm

Packing unit:

1 set incl. fastening & square pin

(Square pin for anti-panic handle/handle sets must be selected and ordered separately, see also note on page 5)

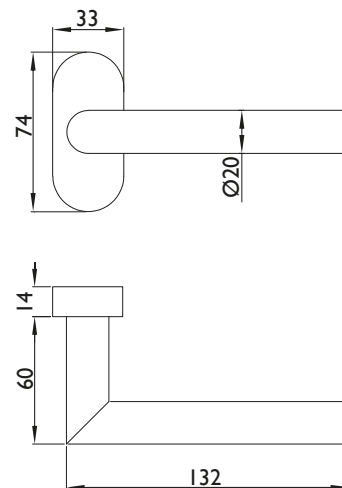

Maintenance-free plain bearing

Retaining spring for precise positioning

Can be used on DIN left/right



















Concealed screws

Additional information on the item is available on our website www.blaugelb.de or directly via the QR code



Version overview:

The framed door handle series in the handle shape 90° shape is available in the **following versions**.

	90° shape Class 4 Item no.: 9131119		 *
	90° shape fire safety Item no.: 9131124		  *
	90° shape Class 4 Item no.: 9131120	Prepared for: TS 40 – 90 mm	
	90° shape fire safety Item no.: 9131125	Prepared for: TS 40 – 90 mm	 
	90° shape/knob Class 4 Item no.: 9131121	Prepared for: TS 65 – 88 mm	
	90° shape/knob offset Class 4 Item no.: 9131122	Prepared for: TS 65 – 88 mm	
	90° shape/knob flat offset Class 4 Item no.: 9131123	Prepared for: TS 65 – 88 mm	
	90° shape/knob fire safety Item no.: 9131126	Prepared for: TS 65 – 88 mm	 
	90° shape/knob offset fire safety Item no.: 9131127	Prepared for: TS 65 – 88 mm	 
	90° shape/knob flat offset fire safety Item no.: 9131128	Prepared for: TS 65 – 88 mm	 
	Clip Rosette PZ oval 14 mm Item no.: 9163925 (see also page 6)		

Note: On **pages 5 to 7** you will find the **suitable accessories** for our blaugelb Framed Door Handle series.



* The **check of the sets** was performed in pairs according to the **specification of DIN 1906 or DIN 18273**.



Depending on the design, the **90° shape offset framed door handle series** is available for the following application areas:

- **Class 4**
- **Fire safety**

FEATURES

Material:

Fine matt stainless steel

DIN direction:

Can be used on both sides with double spring system

Keyhole:

Profile cylinder

Rosette dimensions:

33 x 74 mm (W x H)

Rosette height:

14 mm

Packing unit:

1 set incl. fastening & square pin

(Square pin for anti-panic handle/handle sets must be selected and ordered separately, see also note on page 5)

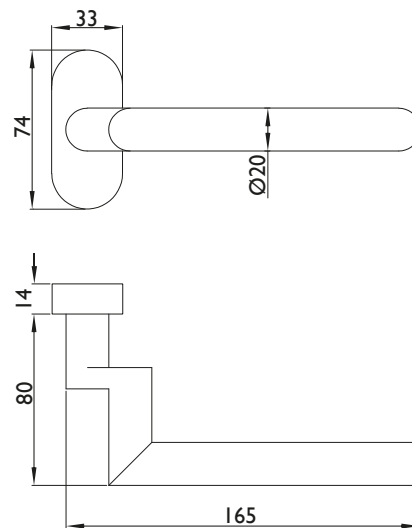

Maintenance-free plain bearing

Retaining spring for precise positioning

Can be used on DIN left/right



















Concealed screws

Additional information on the item is available on our website www.blaugelb.de or directly via the QR code



Version overview:

The framed door handle series in the handle shape 90° shape offset is available in the **following versions**.

	90° shape offset Class 4 Item no.: 9131149		
	90° shape offset fire safety Item no.: 9131154		 
	90° shape offset Class 4 Item no.: 9131150	Prepared for: TS 74 – 90 mm	
	90° shape offset fire safety Item no.: 9131155	Prepared for: TS 74 – 90 mm	 
	90° shape offset/knob Class 4 Item no.: 9131151	Prepared for: TS 80 – 88 mm	
	90° shape offset/knob offset Class 4 Item no.: 9131152	Prepared for: TS 80 – 88 mm	
	90° shape offset/knob flat offset Class 4 Item no.: 9131153	Prepared for: TS 80 – 88 mm	
	90° shape offset/knob fire safety Item no.: 9131100	Prepared for: TS 80 – 88 mm	 
	90° shape offset/knob offset fire safety Item no.: 9131157	Prepared for: TS 80 – 88 mm	 
	90° shape offset/knob flat offset fire safety Item no.: 9131158	Prepared for: TS 80 – 88 mm	 
	Clip Rosette PZ oval 14 mm Item no.: 9163925 (see also page 6)		

Note: On **pages 5 to 7** you will find the **suitable accessories** for our blaugelb Framed Door Handle series.



The **check of the sets** was performed in pairs according to the **specification of DIN 1906 or DIN 18273**.



Depending on the design, the **90° U-shape framed door handle series** is available for the following application areas:

- **Class 4**
- **Fire safety**
- **Anti-panic**

FEATURES

Material:

Fine matt stainless steel

DIN direction:

Can be used on both sides with double spring system

Keyhole:

Profile cylinder

Rosette dimensions:

33 x 74 mm (W x H)

Rosette height:

14 mm

Packing unit:

1 set incl. fastening & square pin

(Square pin for anti-panic handle/handle sets must be selected and ordered separately, see also note on page 5)

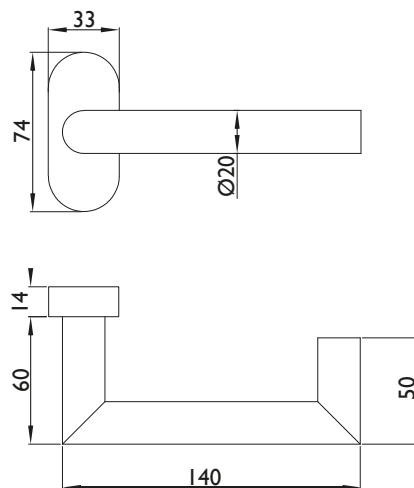

Maintenance-free plain bearing

Retaining spring for precise positioning

Can be used on DIN left/right



























Concealed screws

Additional information on the item is available on our website www.blaugelb.de or directly via the QR code



Version overview:

The framed door handle series in the handle shape 90° U-shape is available in the **following versions**.

	90° U-shape Class 4 Item no.: 9131103		
	90° U-shape fire safety & anti-panic Item no.: 9131174		  
	90° U-shape Class 4 Item no.: 9131160	Prepared for: TS 40 – 90 mm	
	90° U-shape fire safety Item no.: 9131169	Prepared for: TS 40 – 90 mm	 
	90° U-shape anti-panic Item no.: 9163906 (suitable anti-panic square pin on page 5)		  
	90° U-shape/knob Class 4 Item no.: 9131165	Prepared for: TS 65 – 88 mm	
	90° U-shape/knob offset Class 4 Item no.: 9131162	Prepared for: TS 65 – 88 mm	
	90° U-shape/knob flat offset Class 4 Item no.: 9131167	Prepared for: TS 65 – 88 mm	
	90° U-shape/knob fire safety & anti-panic Item no.: 9131176	Prepared for: TS 65 – 88 mm	  
	90° U-shape/knob offset fire safety & anti-panic Item no.: 9131171	Prepared for: TS 65 – 88 mm	  
	90° U-shape/knob flat offset fire safety & anti-panic Item no.: 9131178	Prepared for: TS 65 – 88 mm	  
	Clip Rosette PZ oval 14 mm Item no.: 9163925 (see also page 6)		

Note: On **pages 5 to 7** you will find the **suitable accessories** for our blaugelb Framed Door Handle series.



The **check of the sets** was performed in pairs according to the **specification of DIN 1906, DIN 18273 or DIN EN 179.**

The **knob/handle sets fire safety & anti-panic** can be used as an anti-panic set with the **included pin** as, contrary to purely lever handle sets, knob/handle sets do not require a split pin.



Depending on the design, the **90° U-shape offset framed door handle series** is available for the following application areas:

- **Class 4**
- **Fire safety**
- **Anti-panic**

FEATURES

Material:

Fine matt stainless steel

DIN direction:

Can be used on both sides with double spring system

Keyhole:

Profile cylinder

Rosette dimensions:

33 x 74 mm (W x H)

Rosette height:

14 mm

Packing unit:

1 set incl. fastening & square pin

(Square pin for anti-panic handle/handle sets must be selected and ordered separately, see also note on page 5)

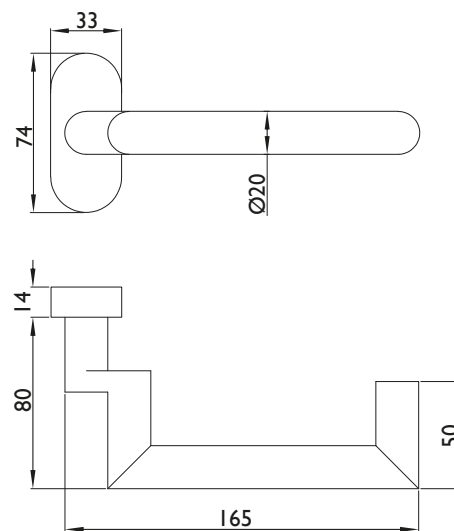

Maintenance-free plain bearing

Retaining spring for precise positioning

Can be used on DIN left/right



























Concealed screws

Additional information on the item is available on our website www.blaugelb.de or directly via the QR code



Version overview:

The framed door handle series in the handle shape 90° U-shape offset is available in the **following versions**.

	90° U-shape offset Class 4 Item no.: 9131173		
	90° U-shape offset fire safety & anti-panic Item no.: 9131194		  
	90° U-shape offset Class 4 Item no.: 9131180	Prepared for: TS 74 – 90 mm	
	90° U-shape offset fire safety Item no.: 9131189	Prepared for: TS 74 – 90 mm	 
	90° U-shape offset anti-panic Item no.: 9163907 (suitable anti-panic square pin on page 5)		  
	90° U-shape offset/knob Class 4 Item no.: 9131185	Prepared for: TS 80 – 88 mm	
	90° U-shape offset/knob offset Class 4 Item no.: 9131182	Prepared for: TS 80 – 88 mm	
	90° U-shape offset/knob flat offset Class 4 Item no.: 9131187	Prepared for: TS 80 – 88 mm	
	90° U-shape offset/knob fire safety & anti-panic Item no.: 9131196	Prepared for: TS 80 – 88 mm	  
	90° U-shape offset/knob offset fire safety & anti-panic Item no.: 9131191	Prepared for: TS 80 – 88 mm	  
	90° U-shape offset/knob flat offset fire safety & anti-panic Item no.: 9131198	Prepared for: TS 80 – 88 mm	  
	Clip Rosette PZ oval 14 mm Item no.: 9163925 (see also page 6)		

Note: On **pages 5 to 7** you will find the **suitable accessories** for our blaugelb Framed Door Handle series.



The **check of the sets** was performed in pairs according to the **specification of DIN 1906, DIN 18273 or DIN EN 179.**

The **knob/handle sets fire safety & anti-panic** can be used as an anti-panic set with the **included pin** as, contrary to purely lever handle sets, knob/handle sets do not require a split pin.



Depending on the design, the **45° U-shape framed door handle series** is available for the following application areas:

- **Class 4**
- **Fire safety**
- **Anti-panic**

FEATURES

Material:

Fine matt stainless steel

DIN direction:

Can be used on both sides with double spring system

Keyhole:

Profile cylinder

Rosette dimensions:

33 x 74 mm (W x H)

Rosette height:

14 mm

Packing unit:

1 set incl. fastening & square pin

(Square pin for anti-panic handle/handle sets must be selected and ordered separately, see also note on page 5)

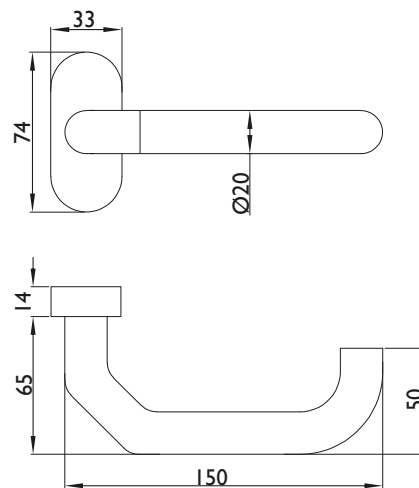

Maintenance-free plain bearing

Retaining spring for precise positioning

Can be used on DIN left/right

Concealed screws

Additional information on the item is available on our website www.blaugelb.de or directly via the QR code



Version overview:

The framed door handle series in the handle shape 45° U-shape is available in the **following versions**.

	45° U-shape Class 4 Item no.: 9131129	Prepared for: TS 50 – 90 mm	
	45° U-shape fire safety & anti-panic Item no.: 9131134		  
	45° U-shape Class 4 Item no.: 9131130	Prepared for: TS 50 – 90 mm	
	45° U-shape fire safety Item no.: 9131135	Prepared for: TS 50 – 90 mm	 
	45° U-shape anti-panic Item no.: 9163908 (suitable anti-panic square pin on page 5)		  
	45° U-shape/knob Class 4 Item no.: 9131131	Prepared for: TS 70 – 88 mm	
	45° U-shape/knob offset Class 4 Item no.: 9131132	Prepared for: TS 70 – 88 mm	
	45° U-shape/knob flat offset Class 4 Item no.: 9131133	Prepared for: TS 70 – 88 mm	
	45° U-shape/knob fire safety & anti-panic Item no.: 9131136	Prepared for: TS 70 – 88 mm	  
	45° U-shape/knob offset fire safety & anti-panic Item no.: 9131137	Prepared for: TS 70 – 88 mm	  
	45° U-shape/knob flat offset fire safety & anti-panic Item no.: 9131138	Prepared for: TS 70 – 88 mm	  
	Clip Rosette PZ oval 14 mm Item no.: 9163925 (see also page 6)		

Note: On **pages 5 to 7** you will find the **suitable accessories** for our blaugelb Framed Door Handle series.



The **check of the sets** was performed in pairs according to the **specification of DIN 1906, DIN 18273 or DIN EN 179.**

The **knob/handle sets fire safety & anti-panic** can be used as an anti-panic set with the **included pin** as, contrary to purely lever handle sets, knob/handle sets do not require a split pin.

OUR LOCATIONS – MEESENBURG NEAR YOU

ANSBACH



Meesenburg Großhandel KG
Schalkhäuser Straße 110 | 91522 Ansbach
Tel.: +49 981 46113-0
Fax: +49 981 46113-30
ansbach@meeseburg.de

BERLIN



Meesenburg Großhandel KG
Köpenicker Straße 26-29 | 10997 Berlin
Tel.: +49 30 257620-0
Fax: +49 30 257620-1000
berlin@meeseburg.de

BISCHOFSWERDA



Meesenburg Großhandel KG
Bahnhofstraße 22 | 01877 Bischofswerda
Tel.: +49 3594 7712-6020
Fax: +49 3594 7712-6001
fachmarkt.bischofswerda@meeseburg.de

DETMOLD



Meesenburg Großhandel KG
Niemeierstraße 18 | 32758 Detmold
Tel.: +49 5231 6005-0
Fax: +49 5231 6005-3901
detmold@meeseburg.de

DORTMUND



Meesenburg Großhandel KG
Giselherstraße 3 | 44319 Dortmund
Tel.: +49 231 9243-0
Fax: +49 231 9243-219
dortmund@meeseburg.de

DÜREN



Meesenburg Großhandel KG
Distelrather Straße 11 | 52353 Düren
Tel.: +49 2421 9170-1000
Fax: +49 2421 9170-1001
dueren@meeseburg.de

ERFURT



Meesenburg Großhandel KG
Europaplatz 1 | 99091 Erfurt
Tel.: +49 361 602490-0
Fax: +49 361 602490-1001
erfurt@meeseburg.de

ESSINGEN



Mayer GmbH
Margarete-Steiff-Str. 13 | 73457 Essingen
Tel.: +49 7365 9206-0
Fax: +49 7365 9206-1001
info@beschlaege-mayer.de

FLENSBURG



Meesenburg Großhandel KG
Westerallee 162 | 24914 Flensburg
Tel.: +49 461 5808-0
Fax: +49 461 5808-1101
flensburg@meeseburg.de

GÖTTINGEN-ROSDORF



Meesenburg Großhandel KG
Am Flüthedamm 2 | 37124 Rosdorf
Tel.: +49 551 693127-0
Fax: +49 551 693127-7001
goettingen@meeseburg.de

GREIFSWALD



Meesenburg Großhandel KG
An der Thronpost 6 | 17489 Greifswald
Tel.: +49 3834 542-3510
Fax: +49 3834 542-3001
greifswald@meeseburg.de

GÜTERSLOH



Meesenburg Großhandel KG
Sandbrink 9 | 33332 Gütersloh
Tel.: +49 5241 933-6
Fax: +49 5241 933-7001
guetersloh@meeseburg.de

HAMBURG



Laarmann & Peez GmbH
Hermann-Buck-Weg 11-17 | 22309 Hamburg
Tel.: +49 40 642161-0
Fax: +49 40 642161-2001
info@laarmann-peeze.de

HAMM



Meesenburg Großhandel KG
Östingstraße 11a | 59063 Hamm
Tel.: +49 2381 9554-0
Fax: +49 2381 9554-4021
hamm@meeseburg.de

HEIDE



Meesenburg Großhandel KG
Bahnhofstraße 2b | 25746 Heide
Tel.: +49 481 787050-0
Fax: +49 481 787050-1001
heide@meeseburg.de

KAVELSTORF



Meesenburg Großhandel KG
Silder Moor 7 | 18196 Kavelstorf
Tel.: +49 38208 634-0
Fax: +49 38208 634-14
kavelstorf@meeseburg.de

KIEL



Meesenburg Großhandel KG
Braunstraße 11 | 24145 Kiel
Tel.: +49 431 71038-0
Fax: +49 431 71038-3001
kiel@meeseburg.de

LEIPZIG – SCHKEUDITZ



Meesenburg Großhandel KG
An der Autobahn 5 | 04435 Schkeuditz
Tel.: +49 34207 4059-0
Fax: +49 34207 4059-1001
leipzig@meeseburg.de

LÜBBECKE



Meesenburg Großhandel KG
Jockweg 58 | 32312 Lübbecke
Tel.: +49 5741 3441-0
Fax: +49 5741 3441-1001
luebbecke@meeseburg.de

MAGDEBURG



Meesenburg Großhandel KG
Fichtestraße 29a | 39112 Magdeburg
Tel.: +49 391 662673-0
Fax: +49 391 662673-1001
magdeburg@meeseburg.de

MAGSTADT



Meesenburg Großhandel KG
Zeppelinstraße 3 | 71106 Magstadt
Tel.: +49 7159 4099-0
Fax: +49 7159 4099-70
magstadt@meeseburg.de

OLDENBURG



Meesenburg Großhandel KG
Ammerländer Heerstraße 260 | 26129 Oldenburg
Tel.: +49 441 97300
Fax: +49 441 9730-511
oldenburg@meeseburg.de

OYTEN



Meesenburg Großhandel KG
Industriestraße 2-6 | 28876 Oyten
Tel.: +49 4207 6668-0
Fax: +49 4207 6668-1000
oyten@meeseburg.de

RELLINGEN



Meesenburg Großhandel KG
Siemensstraße 19 | 25462 Rellingen
Tel.: +49 4101 5055-0
Fax: +49 4101 5055-1000
rellingen@meeseburg.de

RHEINE



Meesenburg Großhandel KG
Röntgenstraße 45 | 48432 Rheine
Tel.: +49 5971 7918-0
Fax: +49 5971 7918-8831
rheine@meeseburg.de

SANGERHAUSEN



Meesenburg Großhandel KG
An der Stollenmühle 1 | 06526 Sangerhausen
Tel.: +49 3464 2743-0
Fax: +49 3464 573489
sangerhausen@meeseburg.de

SCHLESWIG



Meesenburg Großhandel KG
Marie-Curie-Straße 6 | 24837 Schleswig
Tel.: +49 4621 9598-1910
Fax: +49 4621 9598-1001
schleswig@meeseburg.de

St. INGERT



Meesenburg Großhandel KG
Hans-Wilhelmi-Straße 5 | 66386 St. Ingbert
Tel.: +49 6894 31060-1090
Fax: +49 6894 31060-1001
st.ingbert@meeseburg.de

STUTTGART



Meesenburg Großhandel KG
Höfinger Straße 16 | 70499 Stuttgart
Tel.: +49 711 601607-310
Fax: +49 711 601607-3101
stuttgart@meeseburg.de

WAGHÄUSEL



Meesenburg Großhandel KG
Goethestraße 55 | 68753 Waghäusel
Tel.: +49 7254 95901-0
Fax: +49 7254 95901-1001
waghäusel@meeseburg.de

WOLGAST



Meesenburg Großhandel KG
Leeraner Straße 2 | 17438 Wolgast
Tel.: +49 3836 2370-61
Fax: +49 3836 2370-67
wolgast@meeseburg.de



Our local employees there for you



SPECIALIST OUTLET

Pick up your goods here directly from the specialist outlet



MEESENBURG SPECIALIST SHOP
SAFETY & SERVICE
Safety concepts, advice and sales



CUSTOMER BRAND TEAM

Customer brand base, **no** sales or distribution activities

Expert. Honest. Reliable.

For more information, visit
www.blaugelb.de



blaugelb ist eine eingetragene Marke der Meesenburg Gruppe. Alle Rechte vorbehalten.